

Schrittmotor-Leistungsendstufen

IMT-901 Mikroschritt-Treiber

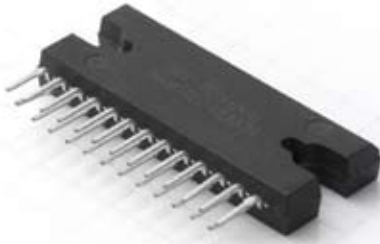

Passende Isolier-Wärmeleitfolie (siehe Zubehör)

Der IMT-901 ist ein Mikroschritt-PWM-Konstantstrom-Treiber. Sinusähnlicher Mikroschritt wird hardwaremäßig im Baustein IMT 901 erzeugt und durch Impulseingänge am Leistungsausgang zur Verfügung gestellt.

Kompl. Info im Internet: www.nanotec.de

Vorteile

- nur 1 IC für Leistung und Logik (bis 2,5 A/Phase) reduziert erheblich den Platzbedarf, Bestückungsaufwand u. somit die Kosten eines kompl. Mikroschritt-Treibers bei einem Minimum an externen Bauelementen und einem Maximum an Funktionen
- 1/1-, 1/2-, 1/4-, 1/8-Schrittschaltung ermöglicht eine individuelle anwendungsbezogene Mikroschritt-Umschaltung mit ruhigem, gleichförmigen Laufverhalten und reduzierten Systemresonanzen
- Stromreduzierung oder Stromnullung reduziert bzw. eliminiert die Verlustleistung u. Erwärmung im Motorstillstand

Maßbild (mm)

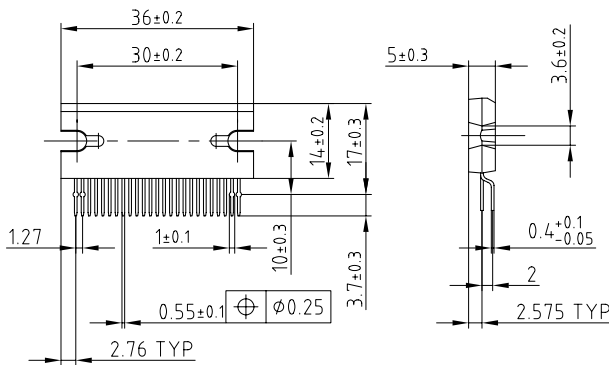

PIN-Belegung

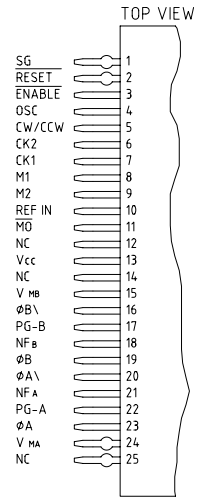

max. Nennwerte (bei 25°C)

Vers. Spannung V_{cc} :	5,5 V
V_M :	40 V
Ausg. Strom I_{out} :	1,5 A (mittel) 2,5 A (spitze)
Verl. Leistung P_d :	5 W/43 W ohne/mit Kühlkörper
	$T_c = 85^\circ\text{C}$
max. Taktfrequenz:	50kHz
Arbeitstemp.:	-40°C bis 85°C
Speichertemp.:	-55°C bis 150°C

Input	Mode	Signalschaltzeiten
M1	M2	t1: Pulsbreite > 10µs
L	L	t2: Pulspause > 10µs
H	L	t3: > 5µs
L	H	t4: > 10µs
H	H	

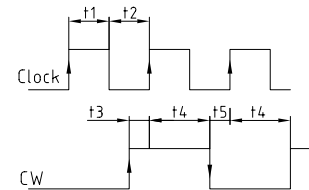

Temperaturverhalten

- INFINITE HEAT SINK
 $R_{th(j-c)} = 1.5^\circ\text{C/W}$
- HEAT SINK
(with 3.5°C/W Heat Pin and 1.5°C contact thermal Resistance; Total 5°C/W)
- NO HEAT SINK
 $R_{th(j-a)} = 25^\circ\text{C/W}$

TRANSIENT THERMAL RESISTANCE

- 2C/W HEAT SINK
- NO HEAT SINK

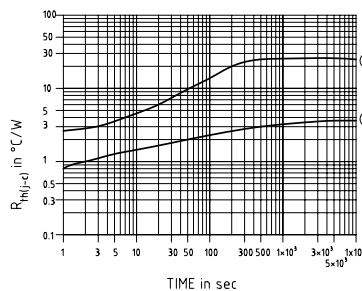
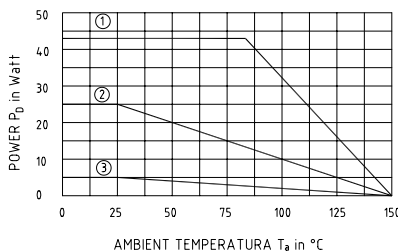

Eingänge

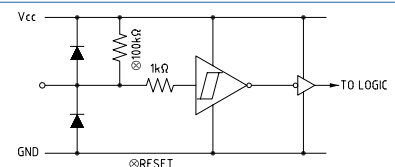

Ein-/Ausgangssignale

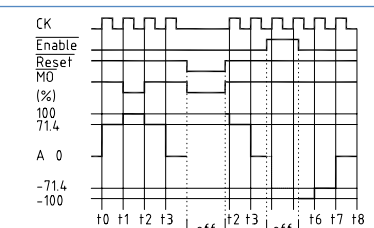

IMT-901

Funktionstabelle

INPUT					MODE
CK1	CK2	CW/CCW	ENABLE	RESET	
	H	L	L	H	CW
	L	L	L	H	INHIBIT
H		L	L	H	CCW
L		L	L	L	INHIBIT
	H	H	L	H	CCW
	L	H	L	H	INHIBIT
H		H	L	H	CW
L		H	L	H	INHIBIT
X	X	X	H	H	Z
X	X	X	X	L	Z

Blockdiagramm (+ externe Beschaltung)

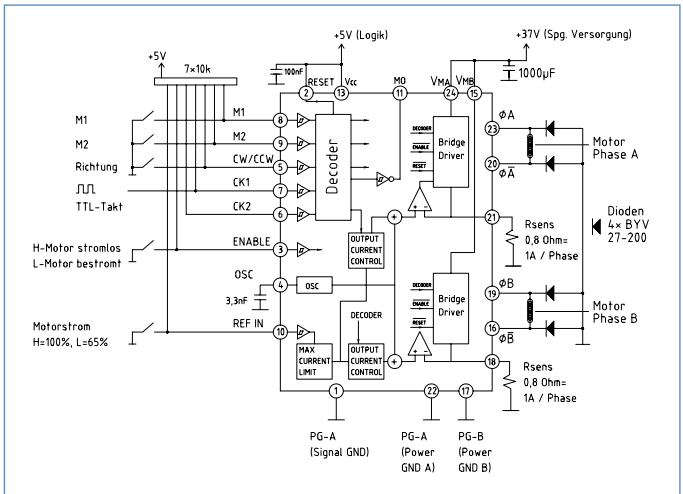

Voll-/Halbschritt-Betrieb

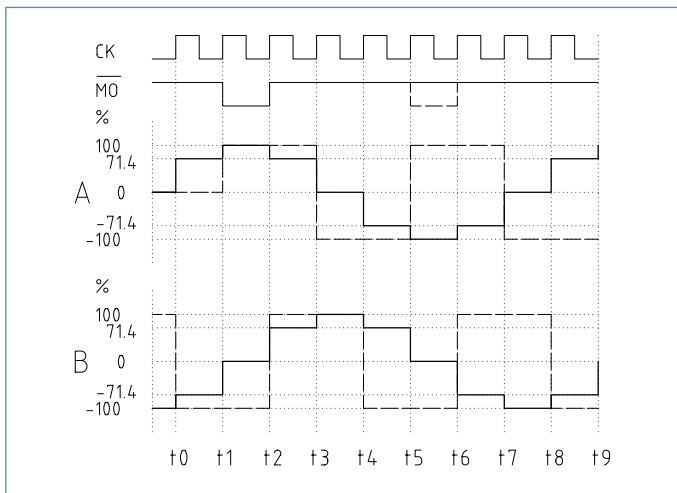

Viertel-/Achtelschritt-Betrieb

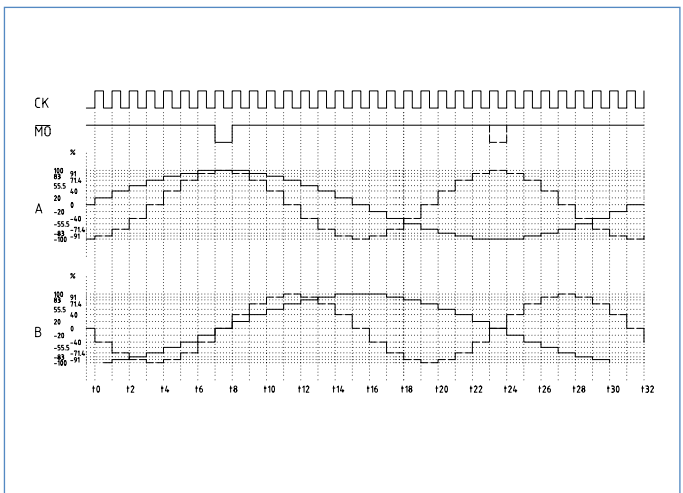

Elektrische Kennwerte 1 (Ta=25°, Vcc=5V, Vm=24V)

CHARACTERISTICS	SYMBOL	TEST CIRCUIT	TEST CONDITION	MIN.	TYP.	MAX.				
NF Terminal Current	I_{NF}	-	SOURCE TYPE	-	170	-				
OSC Frequency	f_{OSC}	-	$C_{OSC}=0.0033\mu F$	25	44	62				
Output Saturation Voltage	$V_{SAT(L)}$	Upper Side	$I_{OUT}=0.8 A$	-	1.8	2.2				
		Lower Side		-	1.1	1.5				
A-B CHOPPING CURRENT (Note 1)	VECTOR	-	REF IN : L $R_{REF}=0.8 \Omega$ $C_{OSC}=0.0033\mu F$	$\phi=0/8$	86	91	96			
				$\phi=1/8$	78	83	88			
				$\phi=2/8$	65.4	71.4	76.4			
				$\phi=3/8$	50.5	55.5	60.5			
				$\phi=4/8$	35	40	45			
				$\phi=5/8$	15	20	25			
				$\phi=6/8$	-	141	-	-		
Feed Back Voltage Step	ΔV_{FB}	-	REF IN : H $R_{REF}=0.8 \Omega$ $C_{OSC}=0.0033\mu F$	$\phi=0/8-1/8$	32	72	112			
				$\phi=1/8-2/8$	24	64	104			
				$\phi=2/8-3/8$	53	93	133			
				$\phi=3/8-4/8$	87	127	167			
				$\phi=4/8-5/8$	84	124	164			
Output T _s Switching Characteristics	t_s	-	$R_L=2\Omega, V_{IN}=0V$ $C_L=15pF$	$\phi=0/8$	-	0.3	-			
				$\phi=1/8$	-	2.2	-			
				$\phi=2/8$	-	1.5	-			
				$\phi=3/8$	-	2.7	-			
				$\phi=4/8$	-	5.4	-			
				$\phi=5/8$	-	5.3	-			
				$\phi=6/8$	-	2.0	-			
Output Leakage Current	Upper Side	I_{OL}	$V_{IN}=30V$	-	-	50				
				-	-	50				
	Lower Side	I_{OL}	$V_{IN}=30V$	-	-	50				
				-	-	50				
	Output Voltage	$V_{OL(MD)}$	-	$I_{OL}=40\mu A$	-	4.5	4.9			
					$V_{OL(MD)}$	-	$I_{OL}=40\mu A$	GND	4.1	0.5
								-	-	-

Note : Maximum Current (I_{MO}) : 100%
2W1-2a: 2W1, 2 phase excitation mode
W1-2a: W1, 2 phase excitation mode
1-2a: 1, 2 phase excitation mode

Elektrische Kennwerte 2 (Ta=25°, Vcc=5V, Vm=24V)

CHARACTERISTIC	SYMBOL	TEST CIRCUIT	TEST CONDITION	MIN.	TYP.	MAX.	UNIT
Input Voltage	High	$V_{IN(H)}$	M1, M2, CW/CCW, REF IN	3.5	-	$V_{CC}+0.4$	V
	Low	$V_{IN(L)}$	ENABLE, CK1, CK2 RESET	GND-0.4	-	1.5	
Input Hysteresis Voltage	V_H	-	-	-	600	-	mV
Input Current	I_{IN}	$I_{IN-1(H)}$	M1, M2, CW/CCW, REF IN $V_{IN}=5.0 V$	-	-	100	nA
		$I_{IN-1(L)}$	RESET, $V_{IN}=0 V$ INTERNAL PULL-UP-RESISTOR	10	50	100	μA
		$I_{IN-2(L)}$	SOURCE TYPE, $V_{IN}=0 V$	-	-	100	nA
Quiescent Current	V_{CC}	I_{CC1}	Output Open RESET : H, ENABLE : L (2.1 - 2 Phase excitation)	-	10	18	mA
		I_{CC2}	Output Open (W1-2, 2W1-2 Phase Excitation) RESET : H, ENABLE : L	-	10	18	
	V_{CC}	I_{CC3}	RESET : L, ENABLE : L	-	5	-	
		I_{CC4}	RESET : H, ENABLE : L	-	5	-	
Comparator Reference Voltage	$V_{NF(H)}$	-	REF IN H Output Open 2 Phase excitation, $R_{NF}=0.7 \Omega$, $C_{OSC}=0.0033\mu F$	0.72	0.8	0.88	V
	$V_{NF(L)}$	-	REF IN H Output Open	0.45	0.5	0.55	
Output Differential	ΔV_O	-	B/A $C_{OSC}=0.0033 \mu F, R_{NF}=0.8 \Omega$	-10	-	10	%
$V_{NF(H)} - V_{NF(L)}$	ΔV_{NF}	-	$V_{NF(L)}, V_{NF(H)}$ $C_{OSC}=0.0033\mu F, R_{NF}=0.8 \Omega$	56	63	70	%
				$V_{CH(MD)}$	$I_{OH}=-40\mu A$	4.5	4.9
Output Voltage	$V_{CH(MD)}$	-	$I_{OH}=-40\mu A$	GND	0.1	0.5	mV
				-	-	-	-